

MODELL: SB12

max 3,0 kg

0,45h

2	1551x218	1/1
1	1549x218	1/1

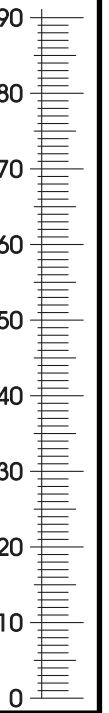

2x	2x	4x	2x	2x	5x	1x
W26	D1	E1	ZO1	EP2	K5	K20

SNGBI

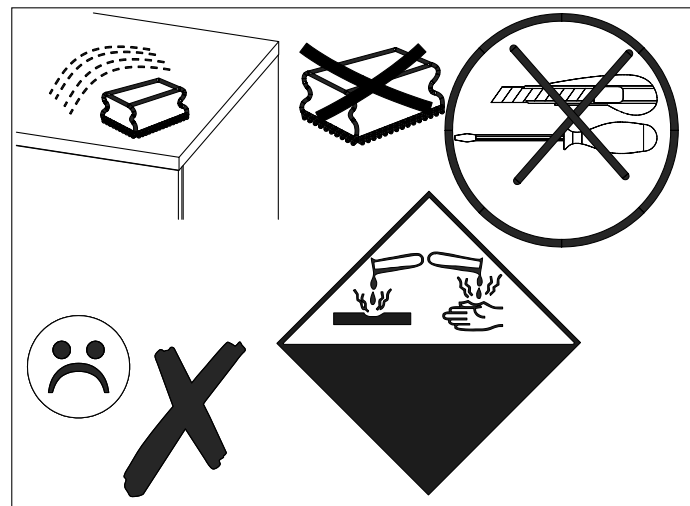
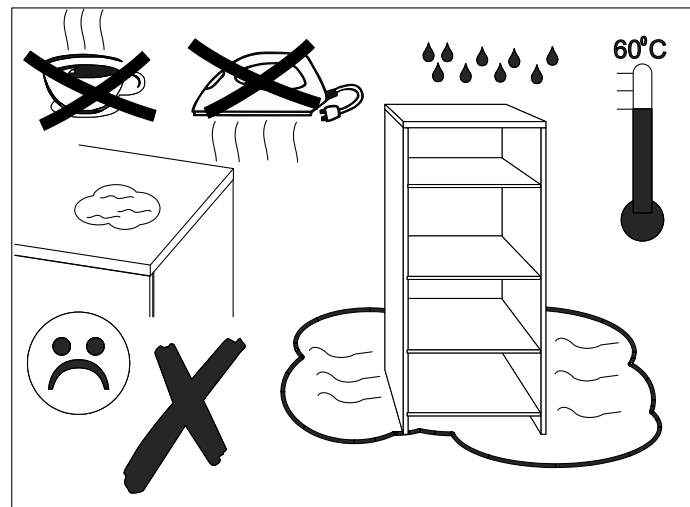
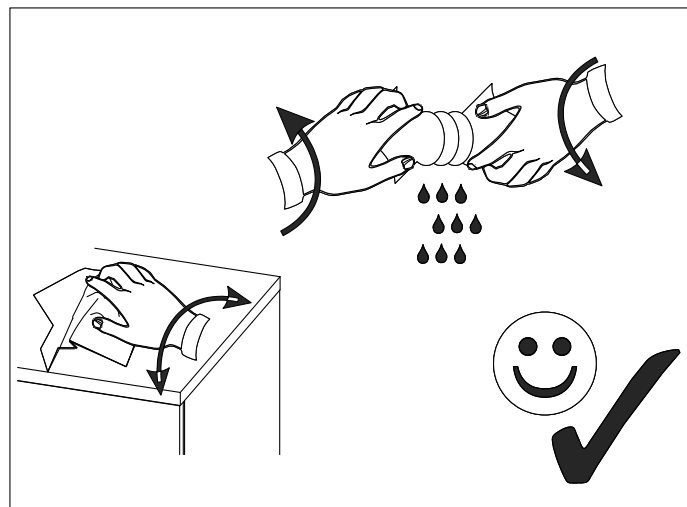
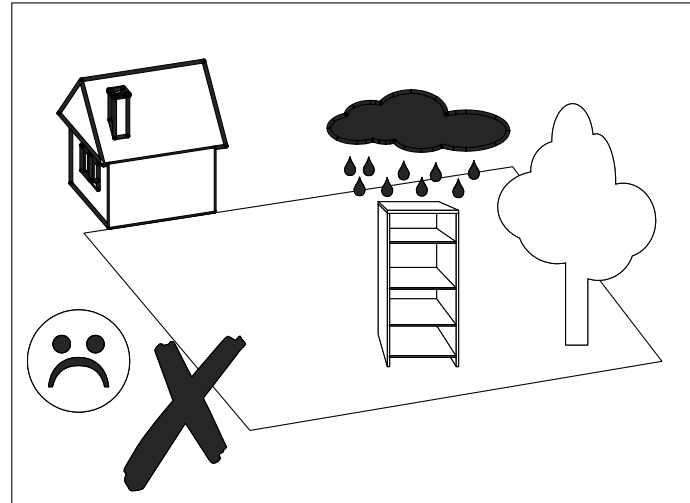
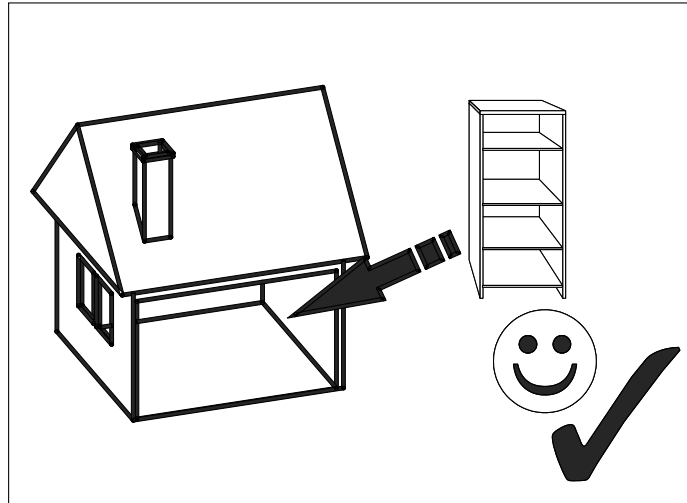

2

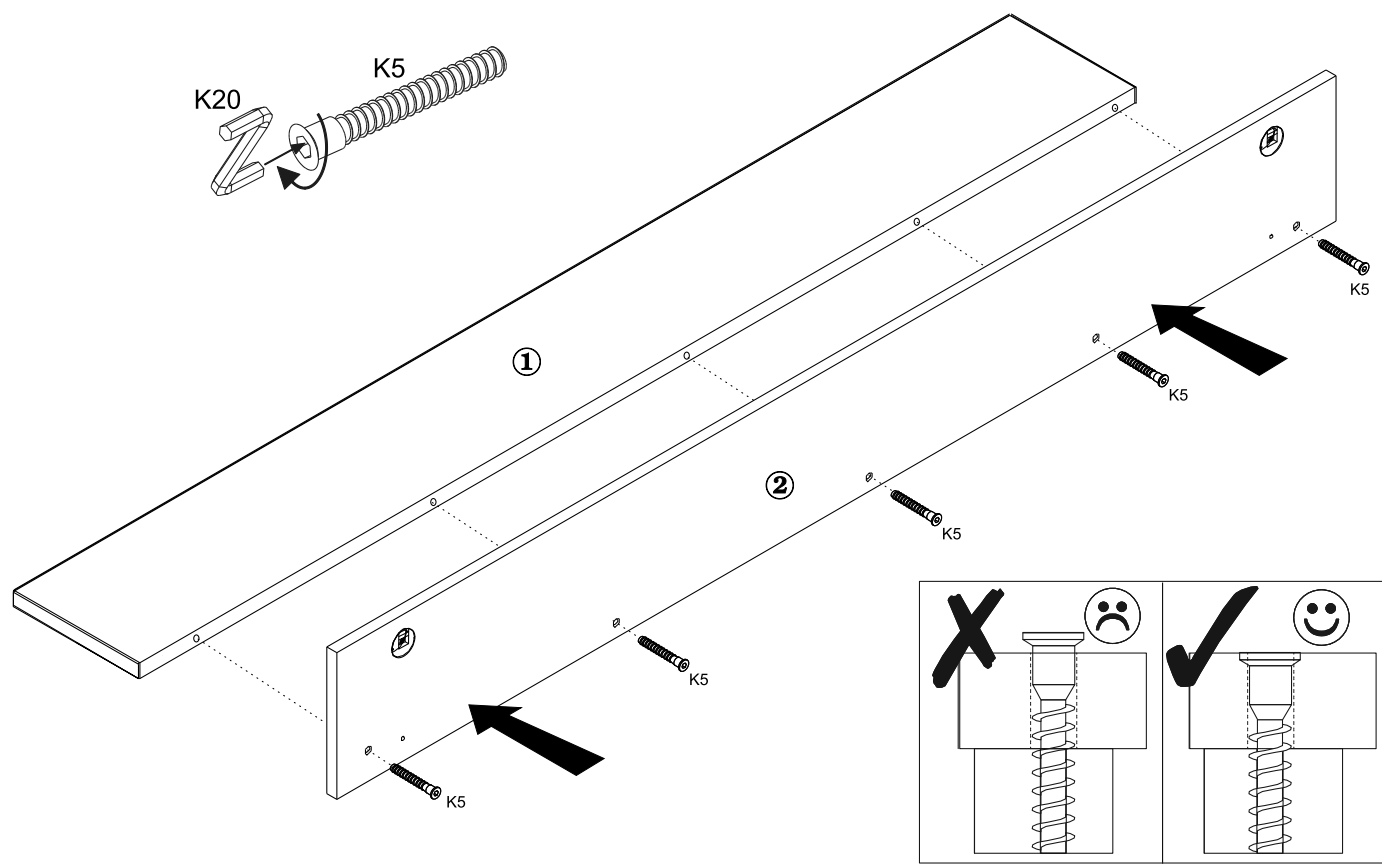

3

